

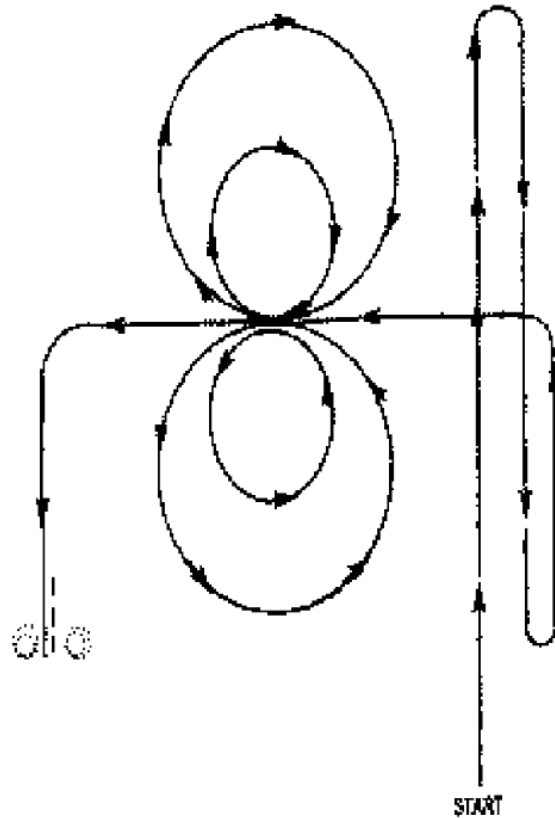

WORKING RANCH HORSE/RANCH BOXING – PATTERN 1

MANDATORY MARKERS ALONG FENCE OR WALL RIDE PATTERN AS FOLLOWS:

1. Start on right side of arena and lope to far end of arena.
2. Stop and rollback to the right. Continue to other end of arena.
3. Stop and rollback to the left. Continue to center of arena.
4. Lope small, slow circle to left.
5. Lope large circle to left with medium speed. Change leads.
6. Lope small slow circle to right.
7. Lope large circle to right with medium speed. Change leads.
8. Continue down arena.
9. Stop and back 10 to 15 feet.
10. Do 360 degree spin right
11. Do 360 degree spin left
12. Hesitate to show completion of pattern.





WORKING RANCH HORSE/RANCH BOXING – PATTERN 2

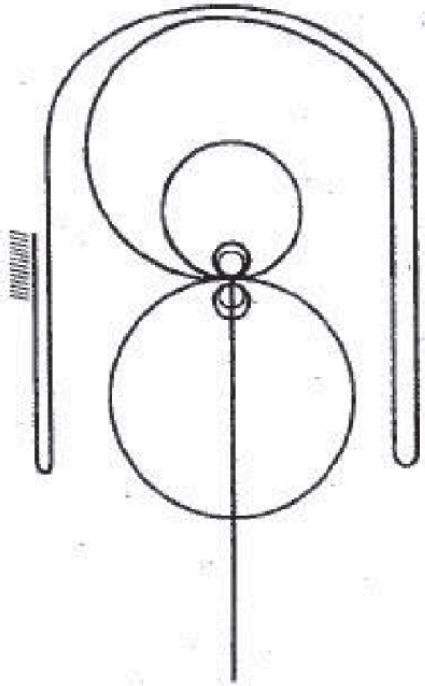

MANDATORY MARKERS ALONG FENCE OR WALL- RIDE PATTERN AS FOLLOWS:

1. Start at end of arena. Run down middle to center marker to a square sliding stop.
2. Complete 2 spins to right.
3. Complete 2 $\frac{1}{4}$ spins left.
4. Begin on right lead and complete one circle right small and slow. Change leads.
5. Complete one circle left large and fast. Change leads.
6. Continue loping around end of arena without breaking gait. Run strait down the right side of the arena past the center marker and do a left rollback.
7. Continue back around the previous circle but do not close this circle. Run down the left side of the arena past the center marker and do a right rollback.
8. Continue past center marker and do a sliding stop.
9. Back at least 10 feet in a straight line.
10. Hesitate to complete pattern.



WORKING RANCH HORSE/RANCH BOXING – PATTERN 3

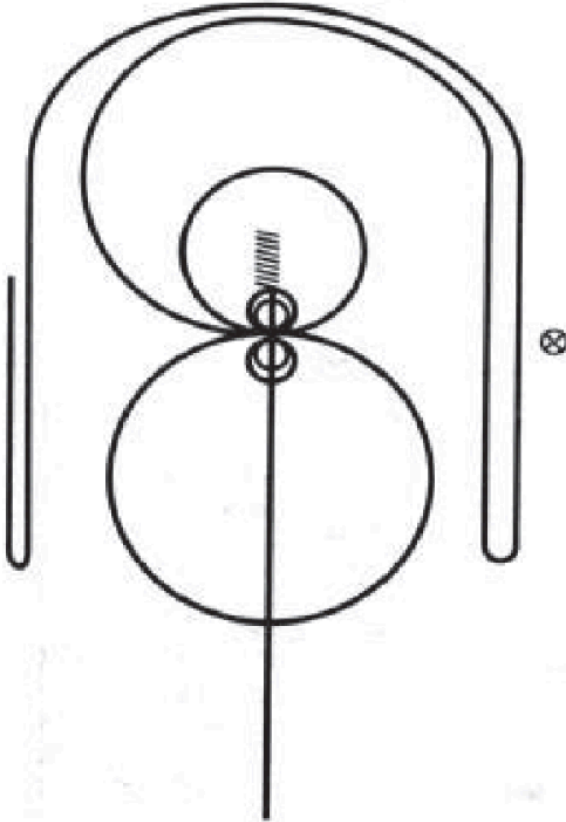

Mandatory Marker Along Fence or Wall Ride Pattern as follows:

1. Start at end of arena. Run past the center marker and do a sliding stop. Back approximately 10 to 15 feet to the center.
2. Complete 2 spins right.
3. Complete 2 1/4 spins left.
4. Begin on right lead and complete one circle right small and slow. Change leads.
5. Complete one circle left large and fast. Change leads.
6. Continue loping around end of arena without breaking gait. Run straight down the right side of the arena past the center marker and do a left rollback.
7. Continue back around the previous circle but do not close this circle. Run down the left side of the arena past the center marker and do a right rollback.
8. Continue past center marker and do a sliding stop.
9. Hesitate to complete pattern.



WORKING RANCH HORSE/RANCH BOXING – PATTERN 4

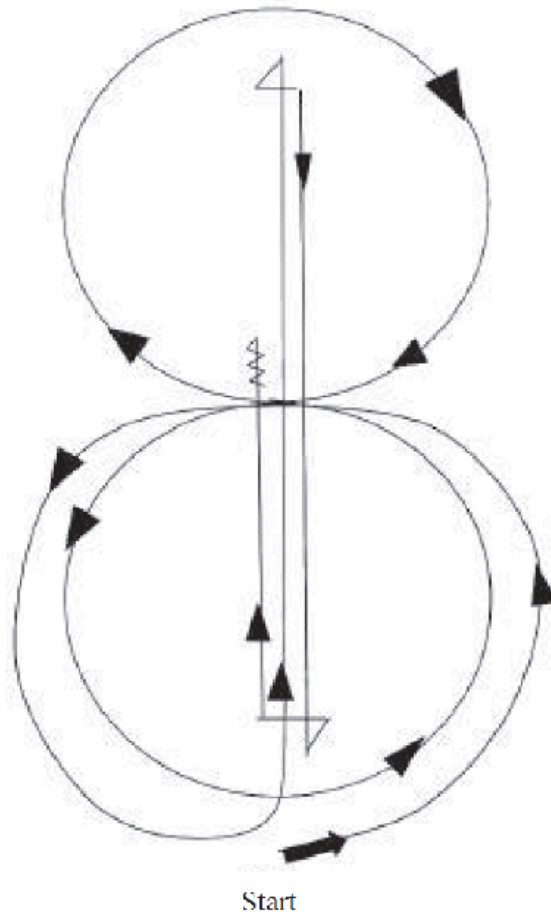

1. Enter the gate on the left lead, loping one circle left.
2. Change leads.
3. Lope one circle right.
4. Change leads.
5. Continue on the left lead around the end, continue up the middle of the arena past the end marker. Stop.
6. 1½ spins left.
7. Continue down the middle of the arena, past the center marker. Stop.
8. 1½ spins right.
9. Continue down the middle of the arena, past the center marker. Stop.
Back at least 10 feet.

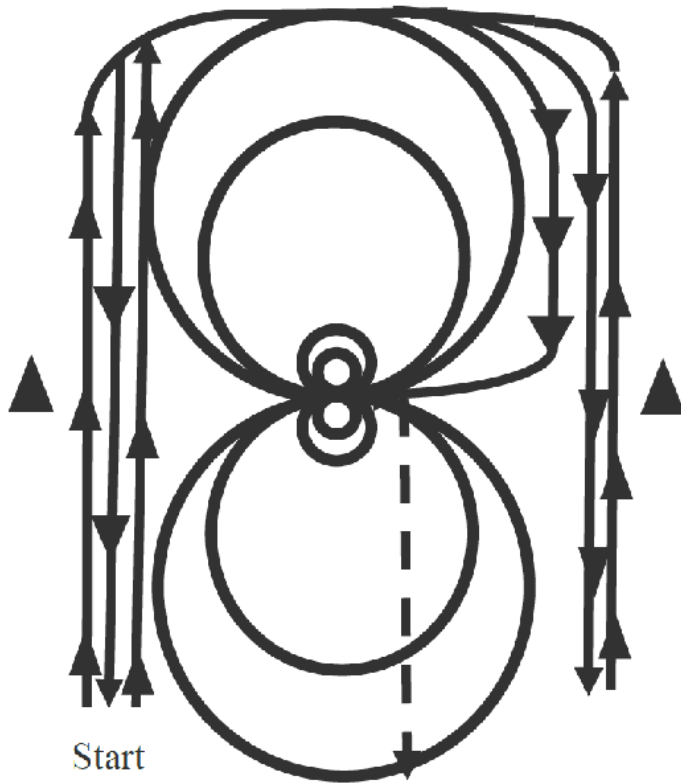

**Green/Youth RANCH REINING –
PATTERN 5**

1. Start on left side of arena, Lope on your right lead around end and run past center marker, Stop, Roll back left.
2. Run past center marker, Stop, Rollback right.
3. Lope back around end at center marker close into right circle. Complete 2 circles on the right lead the first one a small slow, second a large fast, Stop in center.
4. 2 Spins Right.
5. On the left lead complete two circles the first large and fast, second small slow, Stop at center.
6. 2 Spins Left, hesitate;
7. Back 8 –10 feet; exit arena at trot.

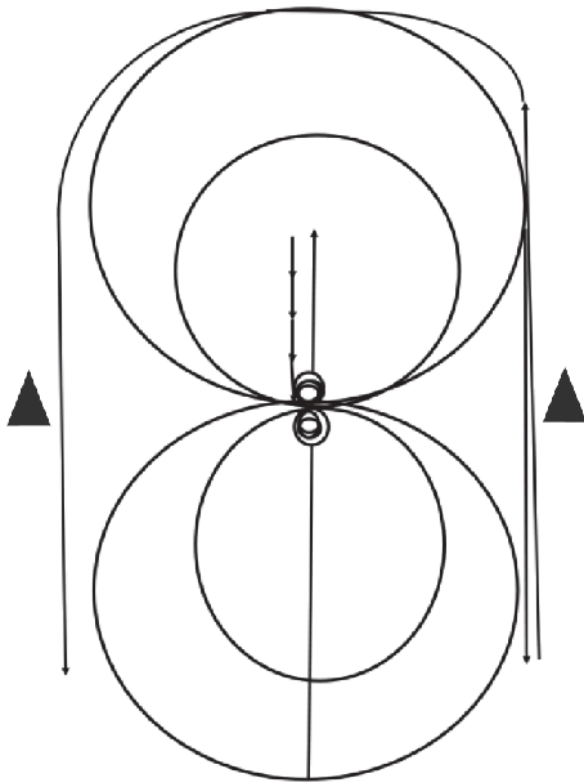

**Green/Youth RANCH REINING –
PATTERN 6**

1. Run down center past marker and stop; Back 8-10 feet, 1/4 turn left.
2. Right lead lope large fast, small slow stop.
3. 3 spins right.
4. Beginning on the left lead complete 2 circles the first one large and fast and the second small and slow, stop.
5. 3 spins left .
6. Right lead lope but do not close circle, go past middle marker, stop. Roll back left.
7. Run down past middle marker, stop, Hesitate to show completion of pattern.



The

Green/Youth RANCH REINING – PATTERN 7

NOVICE RANCH REINING PATTERN # 7

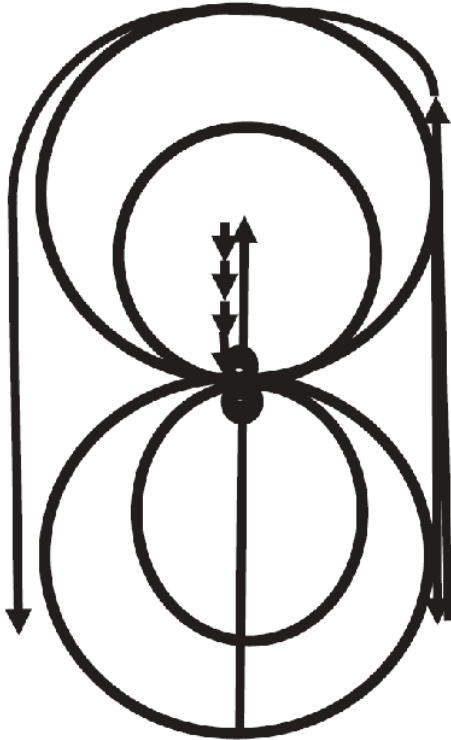

1. Run down center past marker and stop; Back 8-10 feet, 1/4 turn left.
2. Left lead lope large fast, small slow stop.
3. 3 spins left.
4. Beginning on the right lead complete 2 circles the first one large and fast and the second small and slow, stop.
5. 3 spins right.
6. Right lead lope but do not close circle, go past middle marker, stop roll back left.
7. Run down past middle marker, stop, Hesitate to show completion of pattern.



Green/Youth RANCH REINING – PATTERN 8

HORSES MUST TROT TO THE CENTER OF THE ARENA. HORSES MUST STOP PRIOR TO STARTING THE PATTERN BEGINNING AT THE CENTER OF THE ARENA FACING THE ARENA FENCE.

1. Beginning on the left lead, complete 2 circles to the left. Stop at the center of the arena facing the left wall or fence.
2. Complete 2 spins to the left. Hesitate.
3. Beginning on the right lead complete 2 circles to the right. Stop at the center of the arena. Hesitate.
4. Complete 2 spins to the right. Hesitate.
5. Beginning on the left lead, go around the end of the arena, run down the right side of the arena past center marker, stop and roll back right.
6. Continue around the end of the arena to run down the left side of the arena past the center marker. Stop. Back up.

Rider may drop bridle to designated judge.

EXHIBITORS THAT DO NOT TROT IN WILL BE DISQUALIFIED.

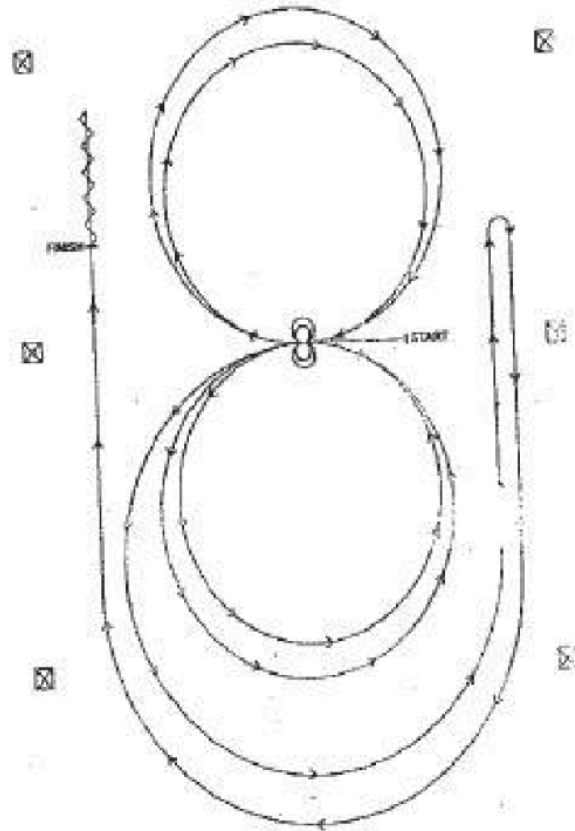



RANCH REINING – PATTERN 9

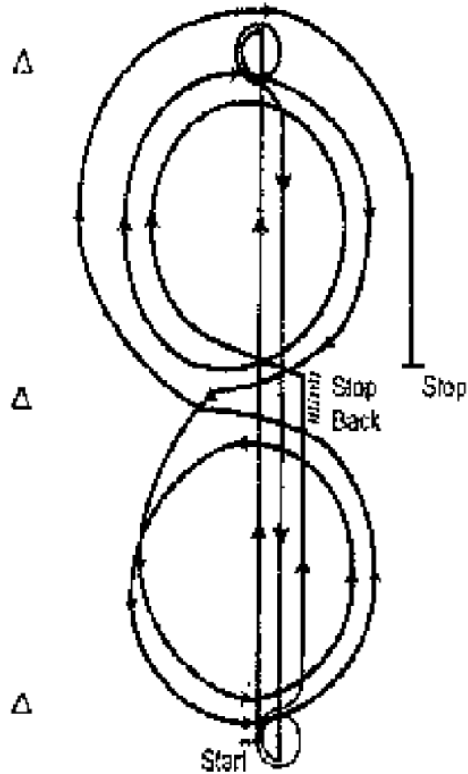

- △ **BEGIN AT END OF THE ARENA**
1. Run to far end of arena past the end marker and stop.
 2. Execute 1 1/2 (one and one-half) spins to the left.
 3. Run to other end of arena past the end marker and stop.
 4. Execute 1 1/2 (one and one-half) spins to the right.
 5. Run past the center marker and stop.
 6. Back 10 to 15 feet in a straight line.
 7. Complete 1/4 (one-quarter) of a turn to the left, hesitate. On right lead complete one small, slow circle and one large, fast circle. Change leads to left.
 8. Complete one small, slow circle and one large, fast circle. Change leads to the right.
 9. Run around the end of arena to the other side, past center marker, at least 20 feet from the fence and stop, hesitate to complete pattern.
 10. Approach judge for inspection and dismissal.
- Rider may drop bridle to the designated judge.

△



RANCH REINING – PATTERN 10

HORSE MUST TROT IN. STOP PRIOR TO STARTING PATTERN. BEGINNING AT THE CENTER OF THE ARENA FACING THE LEFT WALL OF FENCE.

1. Beginning on the right lead, complete 3 circles to the right, the first circle small and slow, the next 2 circles large and fast. Change leads at the center of the arena.
2. Complete 3 circles to the left the first circle small and slow, the next 2 circles large and fast. Change leads at the center of the arena.
3. Continue around previous circle to the right. At the top of the circle, run down the middle to the far end of the arena past the end marker and do a right rollback - no hesitation.
4. Run up the middle to the opposite end of the arena past the end marker and do a left rollback - no hesitation.
5. Run past the center marker and stop. Back up to the center of the arena or at least 10 feet (3 meters). Hesitate.
6. Do a 360 degree spin to the right.
7. Do a 360 degree spin to the left.
8. Hesitate to show completion of pattern.

Rider may drop bridle to the designated judge.

**EXHIBITORS THAT DO NOT TROT IN
WILL BE DISQUALIFIED.**

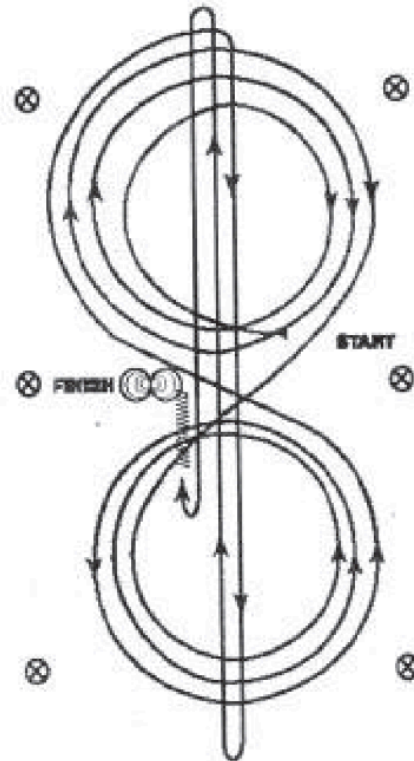



RANCH REINING – PATTERN 11

HORSE MUST TROT IN. STOP PRIOR TO STARTING PATTERN. BEGINNING AT THE CENTER OF ARENA FACING LEFT WALL OR FENCE.

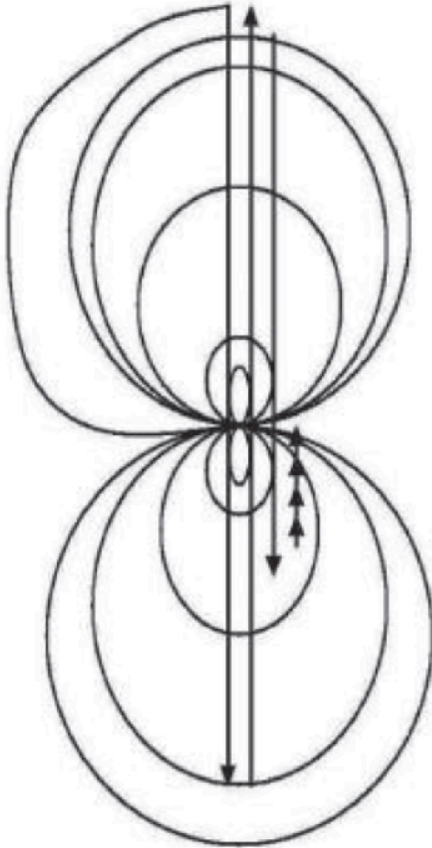

1. Beginning on the right lead, complete 2 circles to the right, the first circle large and fast, the second circle small and slow. Stop at the center of the arena.
2. Complete 2 spins to the right. Hesitate.
3. Beginning on the left lead, complete 2 circles to the left, the first circle large and fast, the second circle small and slow. Stop at center of the arena.
4. Complete 2 spins to the left. Hesitate.
5. Beginning on the right lead, run a large fast circle to the right, and change leads at the center of the arena, run a large fast circle to the left, and change leads at the center of arena (figure 8).
6. Continue around previous circle to the right. At the top of the circle, run down the middle to the far end of the arena past the end marker and do a right rollback– no hesitation.
7. Run up the middle to the opposite end of the arena past the end marker and do a left rollback - no hesitation.
8. Run past the center marker and do a sliding stop. Back up to the center of the arena or at least 10 feet. Hesitate to demonstrate completion of the pattern.

Rider must drop bridle to designated judge.

**EXHIBITORS THAT DO NOT TROT
IN WILL BE DISQUALIFIED.**



RANCH REINING – PATTERN 12

HORSES MUST TROT TO THE CENTER OF THE ARENA. HORSES MUST STOP PRIOR TO STARTING THE PATTERN BEGINNING AT THE CENTER OF THE ARENA FACING THE ARENA FENCE.

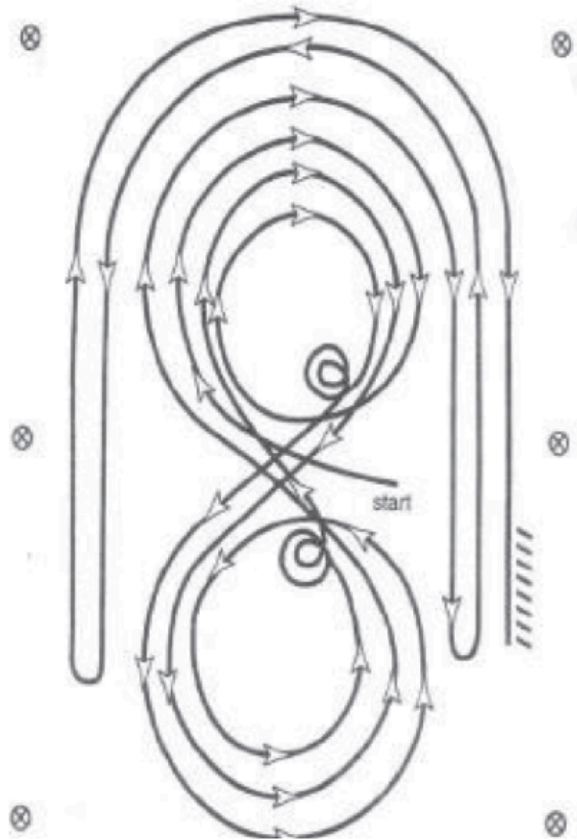

1. Starting at the center do 2 circles to the right. The first, a large fast circle. The second a small slow circle.
2. At center marker stop and do 2 spins to the right.
3. After the spins have been completed; slight hesitation.
4. Do 2 circles to the left. The first a large fast circle. The second a small slow circle.
5. At center marker stop and do 2 spins to the left.
6. After spins completed; slight hesitation.
7. Start a fast figure 8 to the right, changing leads at the center marker.
8. After figure 8 and both lead changes completed, continue a large circle to the right. Do not close this circle. Run down the right side of arena past the center marker, stop and do a rollback to the left. Remain at least 20 feet from the wall or fence. There should be no hesitation between stop and rollback.
9. Continue back around previous circle. Do not close this circle. Run down left side of arena past the center marker, stop and do a rollback to the right. Remain at least 20 feet from wall or fence. There should be no hesitation between stop and rollback.
10. Proceed back around previous two circles. Do not close this circle. Run down right side of arena past center marker and stop. Back at least 10 feet. Hesitate to show completion of pattern.



RANCHMANSHIP – PATTERN 13

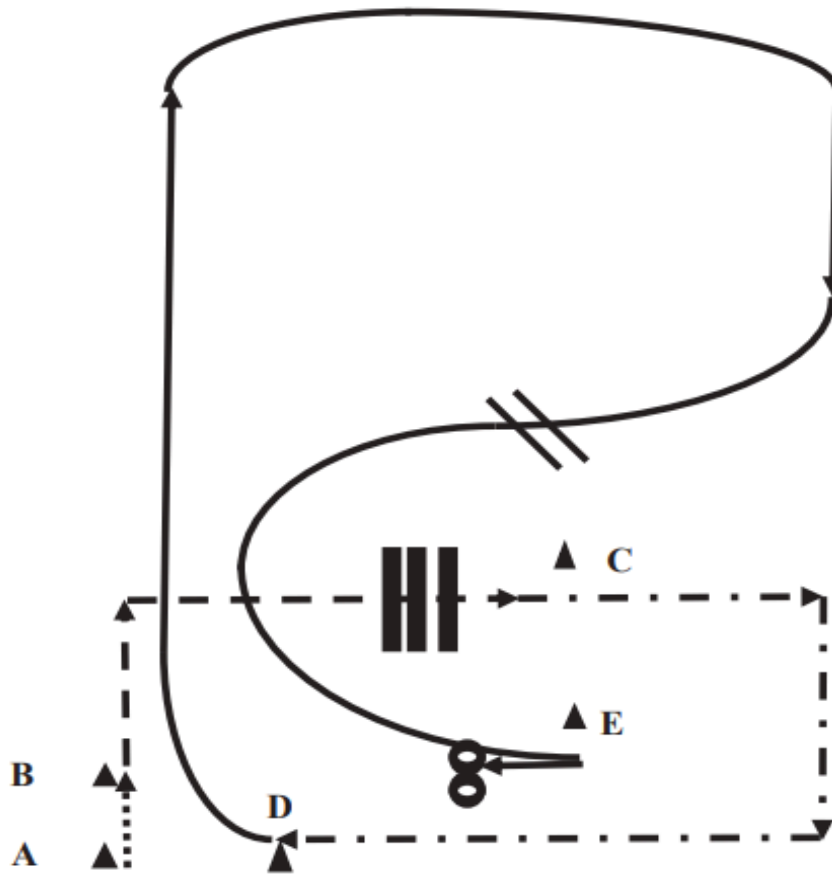

1. Walk from A to B.
2. At B trot over poles to C.
3. At C extended trot to D.
4. Lope right lead up arena and close circle to center and change to left lead.
5. Lope to right side of cone E and stop; back 8 to 10 feet.
6. Two (2) spins to the left.
7. $2\frac{1}{4}$ spins to the right.

RANCHMANSHIP – PATTERN 14

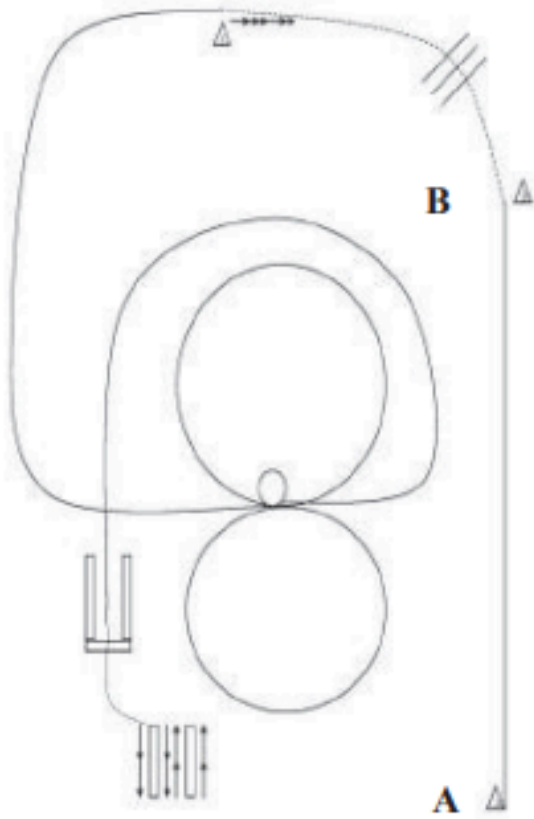

1. Left lead lope A to B.
2. At B break to a trot.
3. Cross Over Poles.
4. Trot to next cone and stop.
5. Back 5 steps.
6. Left lead lope to center, small slow circle.
7. Stop.
8. 2 spins left.
9. Right lead lope small slow; in center change to left lead.
10. Continue to lope left lead into chute; in chute transition to walk.
11. Walk to log and side pass right.
12. Side pass left.



Ohio Foundation Quarter Horse Association – 2024 Pattern Book

RANCHMANSHIP – PATTERN 15

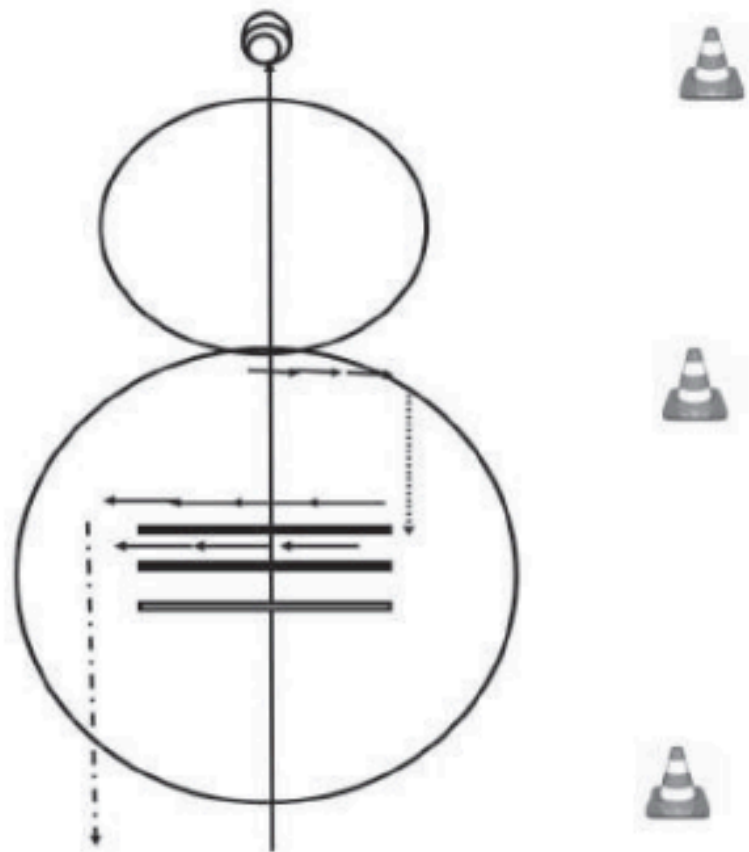

1. Left lead lope down center of arena over poles past the end marker; stop.
2. 3 1/2 spins left.
3. Lope Right lead to center of pen, Turn right lope small slow circle change to left lead.
4. Lope large fast circle stop in center of pen.
5. Back 6-8 feet 90 turn left.
6. Walk to the first pole exhibitor comes to and side passes to the right.
7. Exit at trot to end of arena.

RANCHMANSHIP – PATTERN 16



Ohio Foundation Quarter Horse Association – 2024 Pattern Book

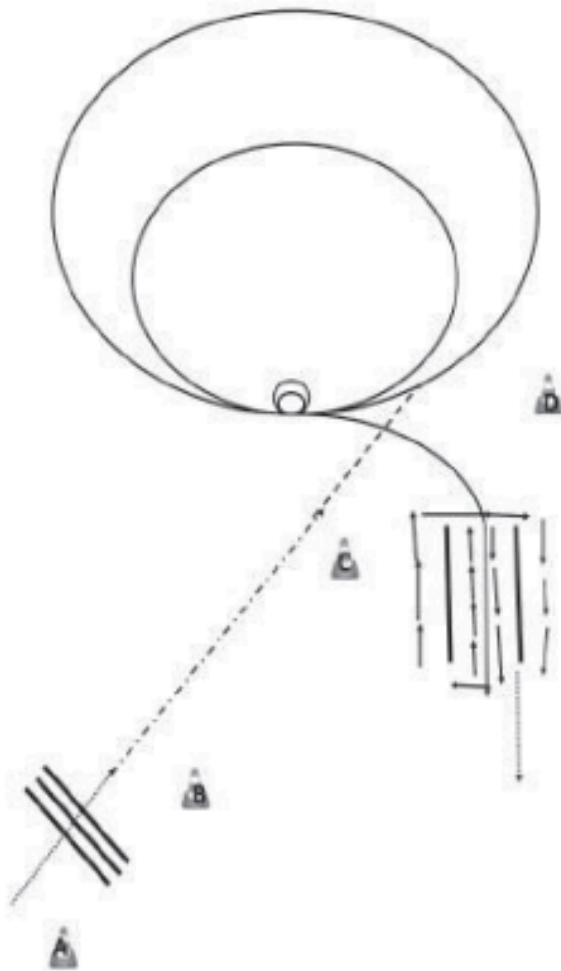

1. Walk from A to B.
2. At B extended trot to C.
3. At C return to trot.
4. At D left lead lope large fast to a small slow and stop in the center.
5. 2 spins left.
6. Trot thru chute, stop, 90 to right.
7. Side pass right.
8. Back to 2nd pole.
9. Side pass left.
10. Walk to exit arena.



RANCH TRAIL – PATTERN 17

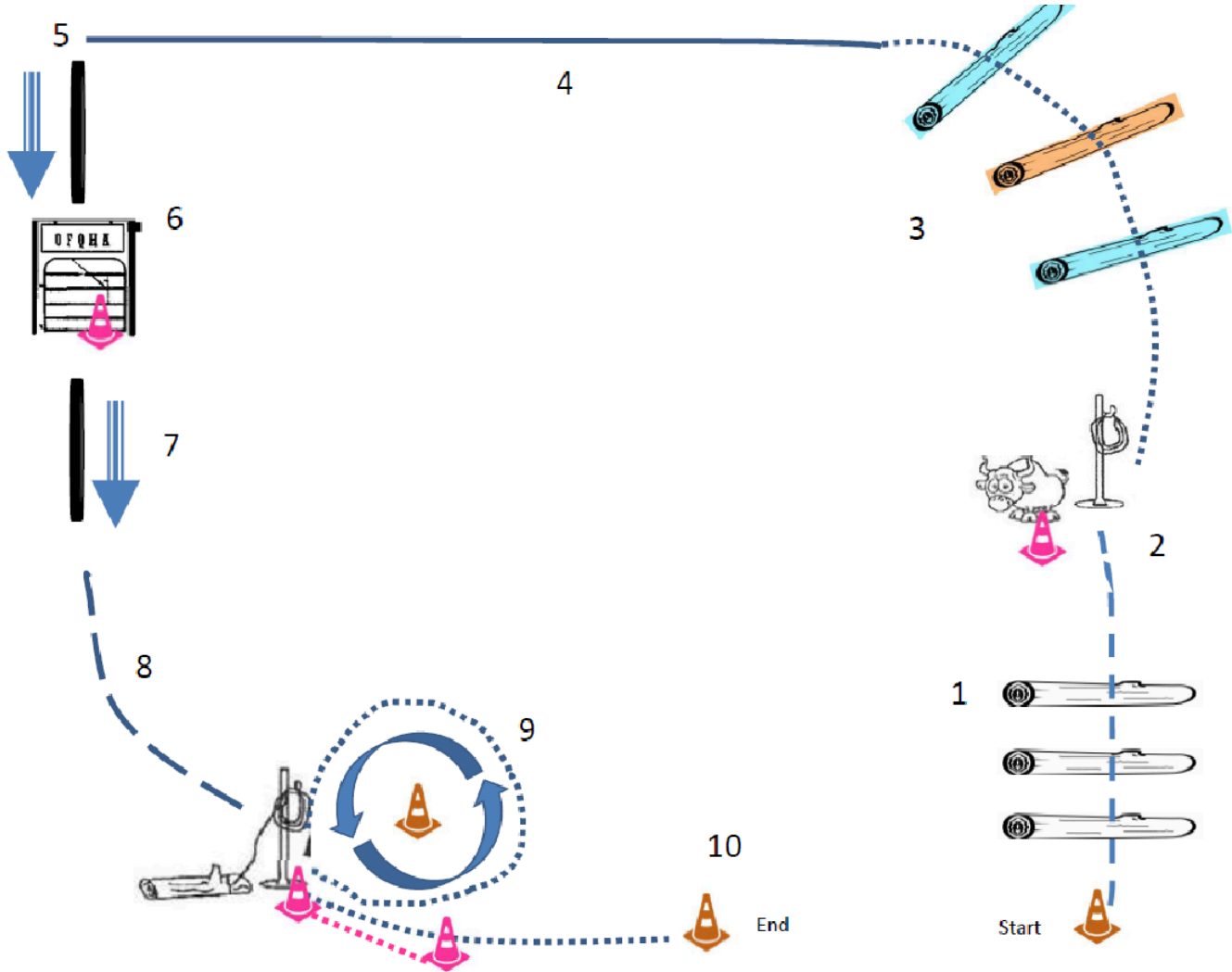



Ohio Foundation Quarter Horse Association – 2024 Pattern Book

1. Trot over poles
2. Trot to Steer/ Attempt to Rope/ 2 Attempts **YOUTH** *Swing rope, no throw needed*
3. Walk over elevated pole, large log and 2nd elevated pole
4. Left Lead Lope to pole
5. Stop Side pass left
6. Work Gate with left Hand **YOUTH** *gate will be unlatched, walk through gate holding gate, close gate, latch is not required.*
7. Side pass right
8. Extended Trot To Log Drag
9. Walk/ Drag Log/ Return Log **YOUTH** *drag cone to cone*
10. Walk to cone finish

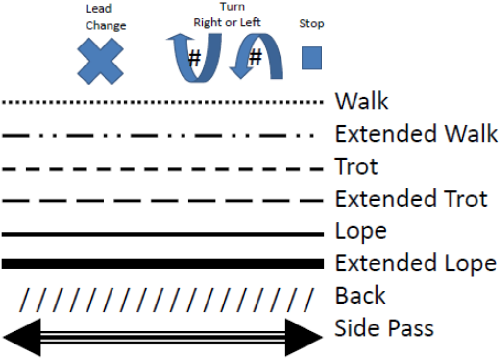

Walk/Trot class will replace Lope with Extended Trot



Ohio Foundation Quarter Horse Association – 2024 Pattern Book

Ranch Trail Pattern 29

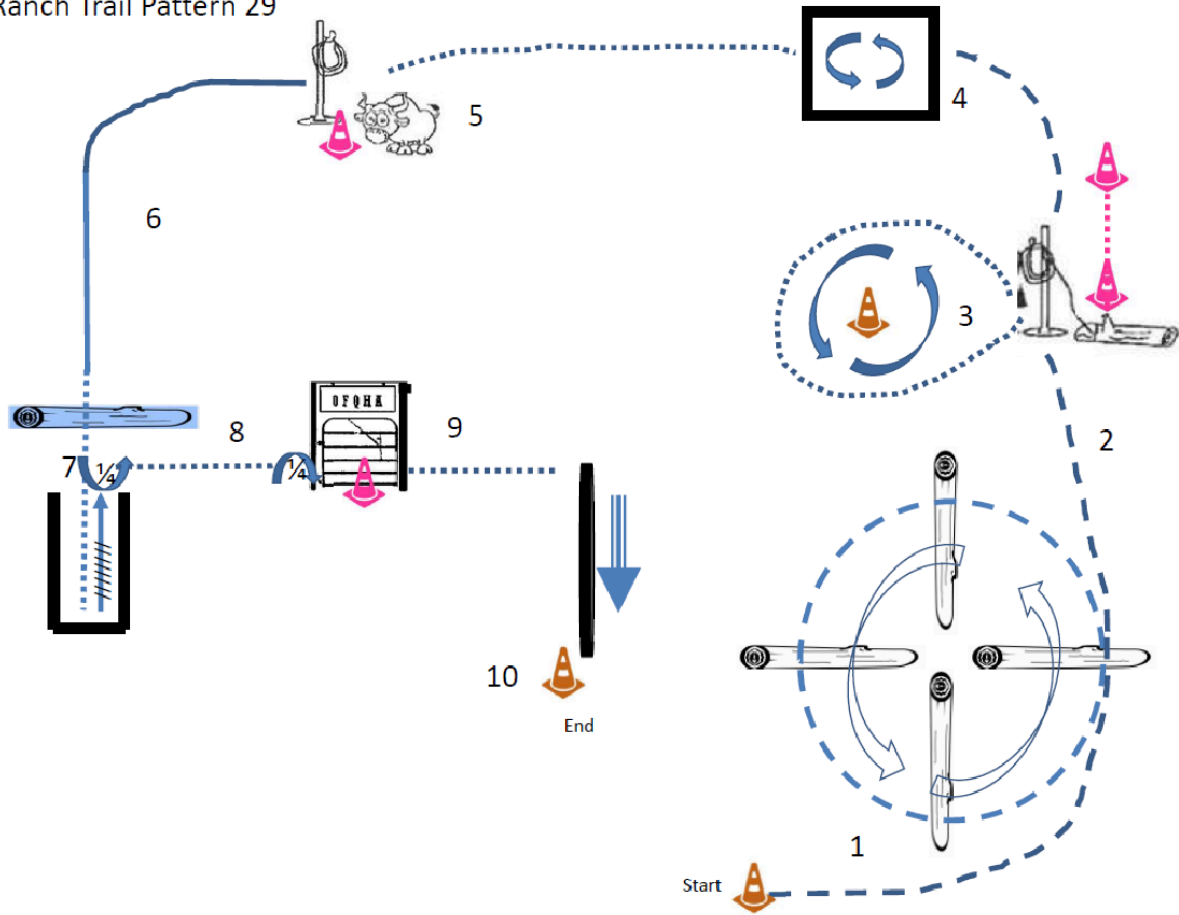



Ohio Foundation Quarter Horse Association – 2024 Pattern Book

1. Trot large circle over poles
2. Trot to Log Drag
3. Walk, Drag log around cone **YOUTH – Drag cone to cone**
4. Trot to Box, enter box 360 turn Left
5. Walk to Steer/ Attempt to Rope/ 2 Attempts **YOUTH Swing no throw needed**
6. Left Lead Lope to elevated log
7. Break to walk, walk over elevated log
8. Walk into Chute/ Stop/ Back Out
9. ¼ turn left/ Walk to Gate/ ¼ turn right/ Work Gate with Left Hand **YOUTH gate will be unlatched, walk through gate holding gate, close gate, latch is not required.**
10. Walk to Pole/ Side Pass Right over Ground Pole to cone

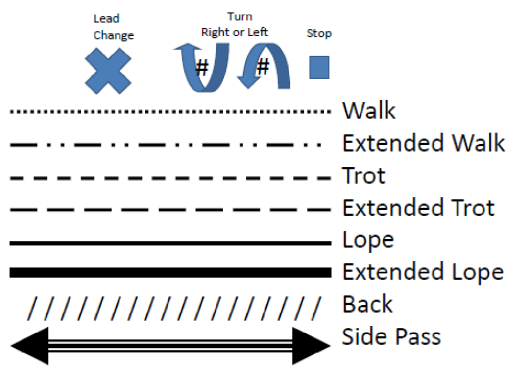

Walk/Trot class will replace Lope with Extended Trot



RANCH TRAIL – PATTERN 19

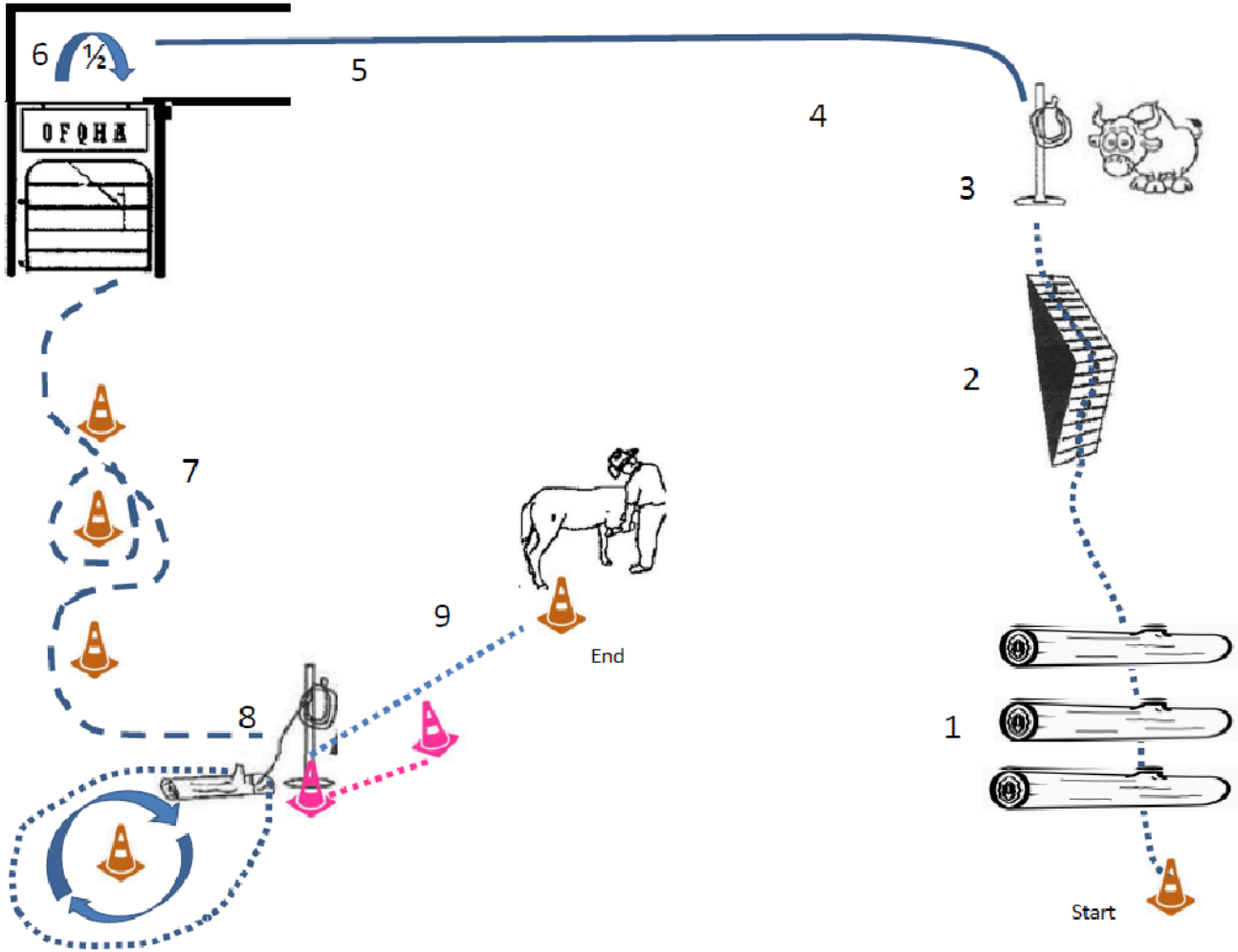



Ohio Foundation Quarter Horse Association – 2024 Pattern Book

- 1. Walk over poles
- 2. Walk to and over bridge
- 3. Walk to Steer/ attempt to Rope (2 Attempts) **YOUTH Swing rope, no throw needed**
- 4. Lope Left Lead into Chute
- 5. 180 Turn to the right in the Chute
- 6. Side Pass Right to Gate/Work Gate with Right Hand **YOUTH gate will be unlatched, walk through gate holding gate, close gate, latch is not required.**
- 7. Trot through cones/ circle middle cone
- 8. Trot to Log Drag/ Drag log and return **YOUTH Drag cone to cone**
- 9. Walk to cone/ Dismount/ Pick up Right front foot

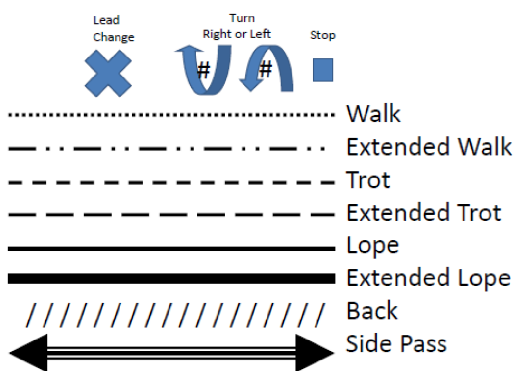

Walk/Trot class will replace Lope with Extended Trot



Ohio Foundation Quarter Horse Association – 2024 Pattern Book



Pattern 24A

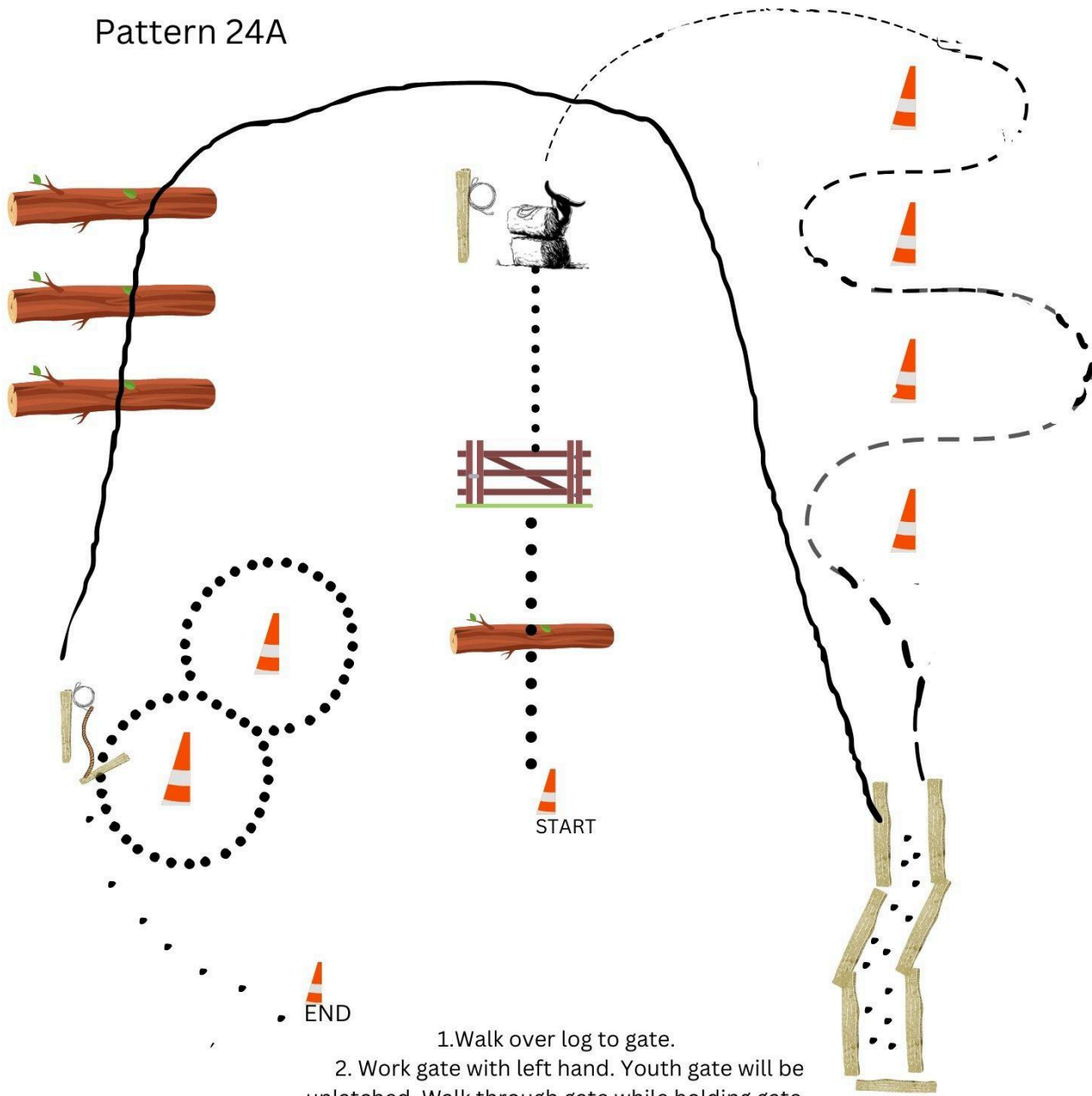

1. Walk over log to gate.
2. Work gate with left hand. Youth gate will be unlatched. Walk through gate while holding gate. Close gate, latch is not required.
3. Walk to steer and rope (2 attempts). Youth swing rope, no throw needed.
4. Trot through serpentine cones.
5. Walk into shoot.
6. Back out of shoot.
7. Lope left lead over logs to log drag.
8. Drag log in figure 8 around cones. Youth drag from cone to cone.
9. Walk to end cone.

..... Walk
 - - - - - Trot
 _____ Lope



Ohio Foundation Quarter Horse Association – 2024 Pattern Book

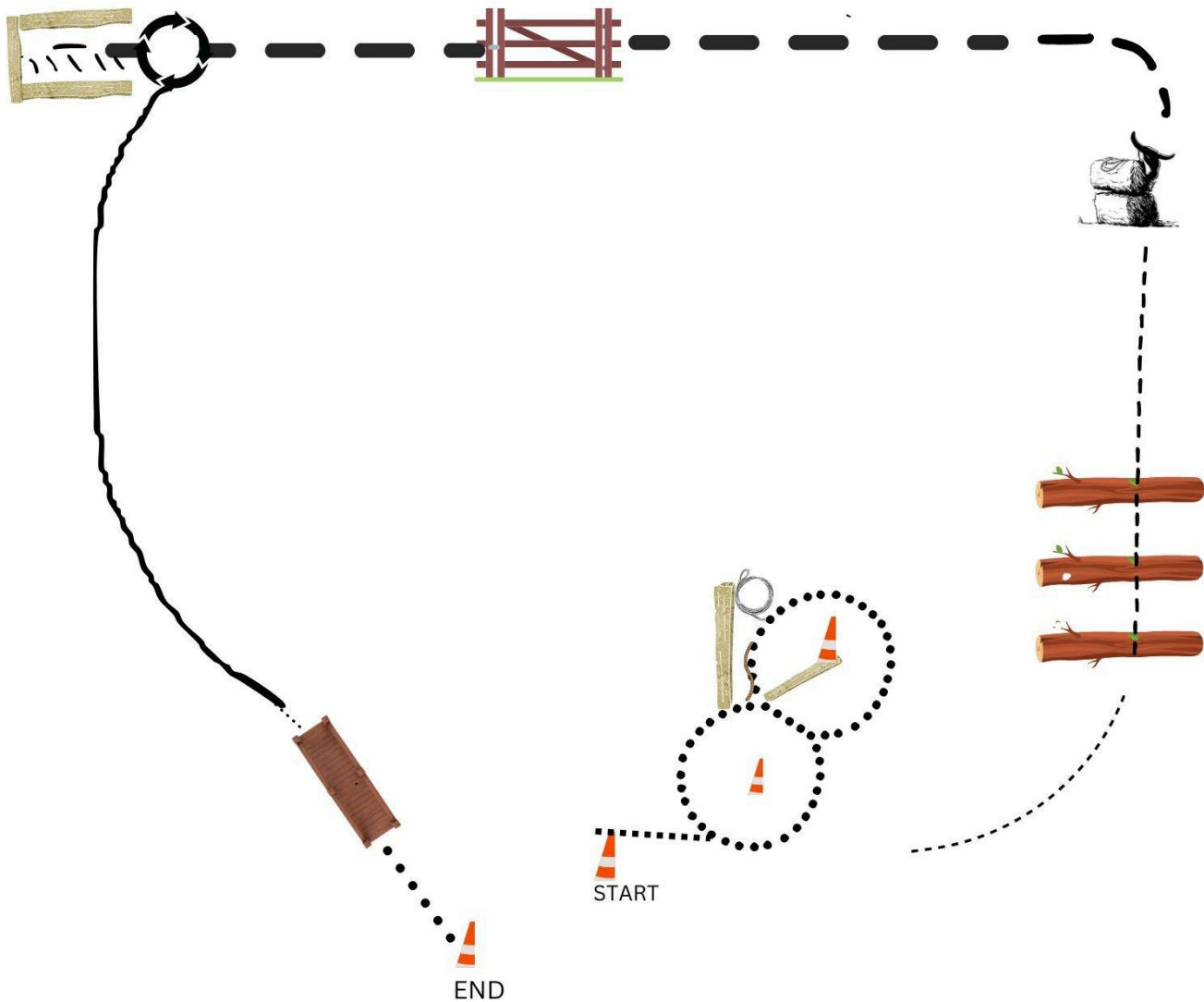

- Walk
- Trot
- Lope

Pattern 24B

1. Walk to drag figure 8. Youth only drag from cone to cone.
2. Trot over poles to steer.
Rope steer (2 Attempts). Youth only swing, throw is not required.
3. Extended trot to gate.
Work with right hand. Youth gate will be unlatched. Walk through gate while holding gate. Close gate, latch is not required.
4. Extended trot to shoot.
5. Back out of shoot and do 1 1/4 turn
6. Lope left lead to bridge.
7. Walk over bridge to cone.



Pattern 24C

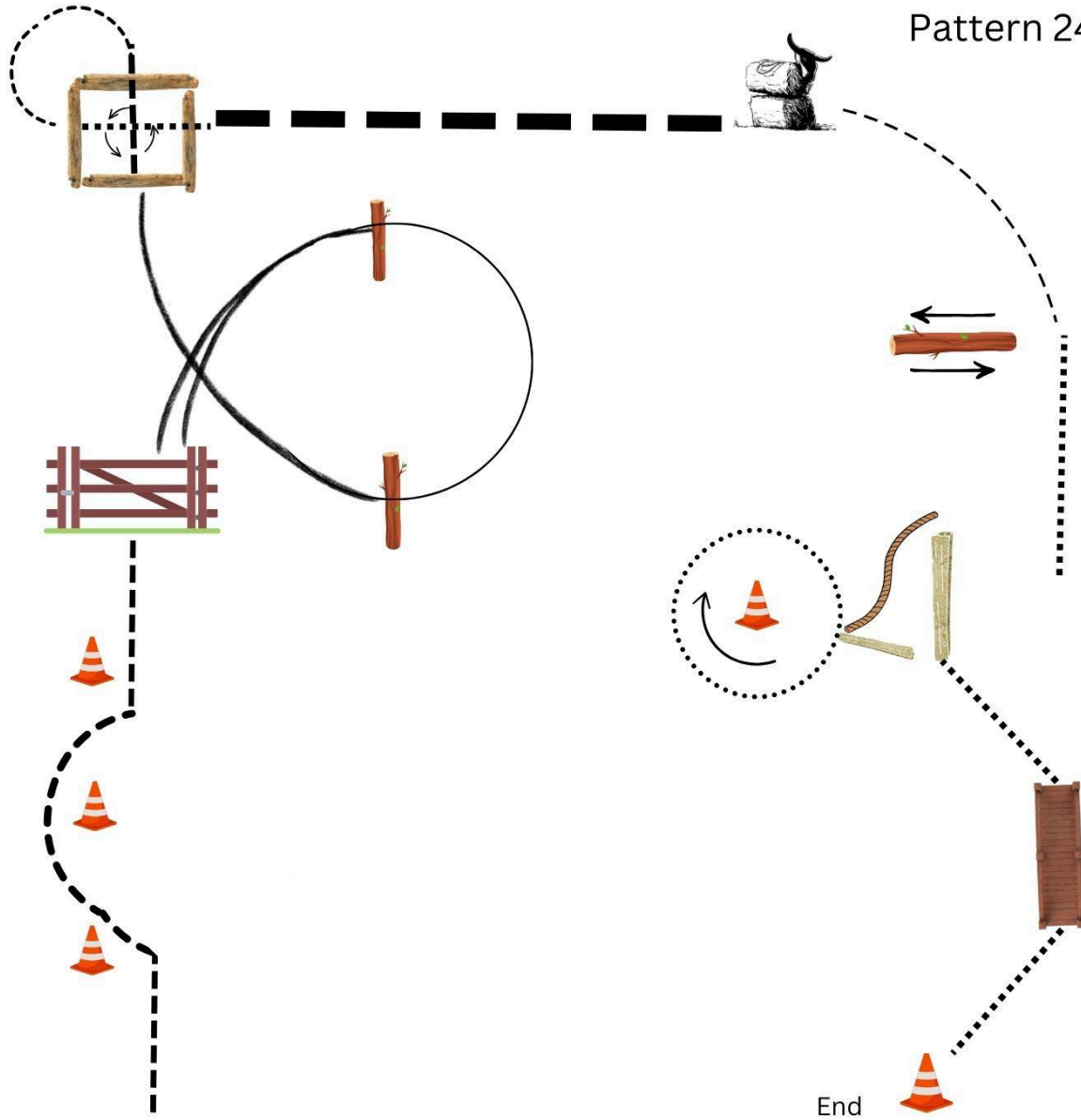

Start

1. Jog through serpentine to gate.
2. Work gate with left hand. Youth gate will be unlatched. Walk through gate while holding gate. Close gate, latch is not required.
3. Lope on right lead over poles.
4. Jog through box and into box
5. Stop and do 360 turn to left.
6. Walk out and extended jog to steer and rope(2 attempts). Youth only swing. No throw required.
7. Jog to pole and side pass both ways.
8. Walk to log drag and drag log to right. Youth only required to drag from cone to cone.
9. Walk to and over bridge.
10. Walk to end.

- Walk
- Trot
- Lope